

PHILIPS

Café Aromis

8000 series

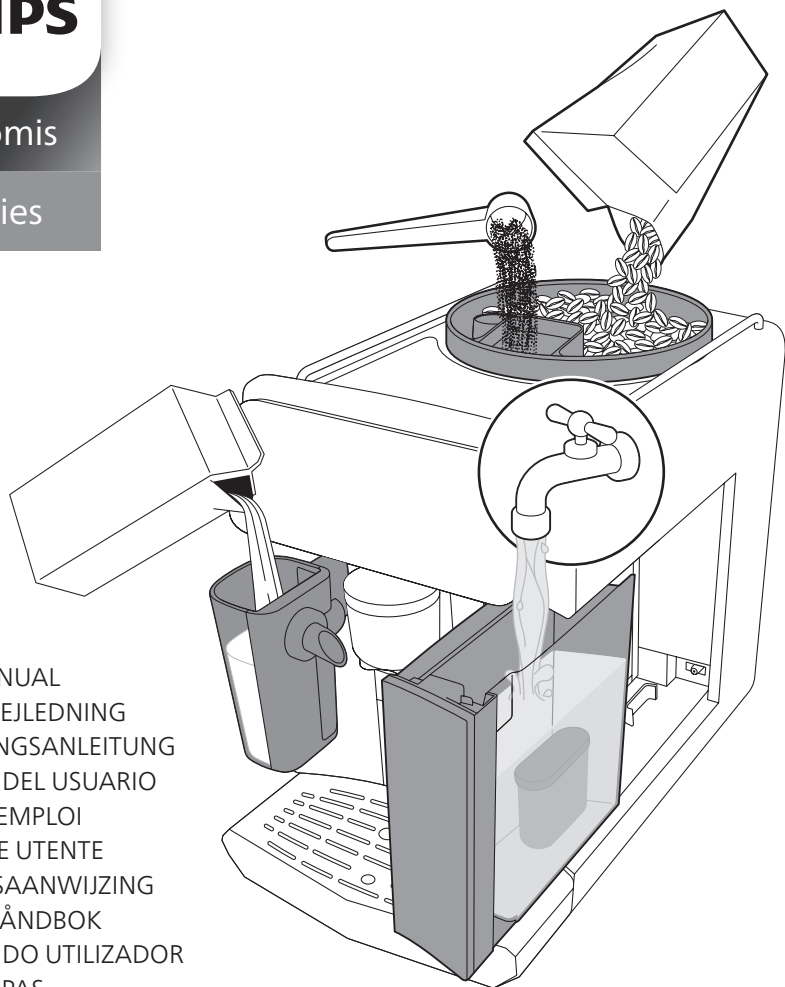

EN USER MANUAL
DA BRUGERVEJLEDNING
DE BEDIENUNGSANLEITUNG
ES MANUAL DEL USUARIO
FR MODE D'EMPLOI
IT MANUALE UTENTE
NL GEBRUIKSAANWIJZING
NO BRUKERHÅNDBOK
PT MANUAL DO UTILIZADOR
FI KÄYTTÖOPAS
SV ANVÄNDARHANDBOK
EL ΕΓΧΕΙΡΙΔΙΟ ΧΡΗΣΗΣ
TR KULLANIM KILAVUZU
BG РЪКОВОДСТВО ЗА
ПОТРЕБИТЕЛЯ
CS UŽIVATELSKÁ PŘÍRUČKA
ET KASUTUSJUHEND
HE מדריך למשתמש
HR KORISNIČKI PRIRUČNIK
HU FELHASZNÁLÓI KÉZIKÖNYV
LV LIETOT JA ROKASGR MATA
LT NAUDOTOJO VADOVAS
MK КОРИСНИЧКО УПАТСТВО

PL INSTRUKCJA OBSŁUGI
RO MANUAL DE UTILIZARE
SL UPORABNIŠKI PRIROČNIK
SK NÁVOD NA POUŽITIE
SR УПУТСТВО ЗА КОРИШЋЕЊЕ
SQ MANUALI I PËRDORIMIT
UK ПОСІБНИК КОРИСТУВАЧА



www.home.id



A

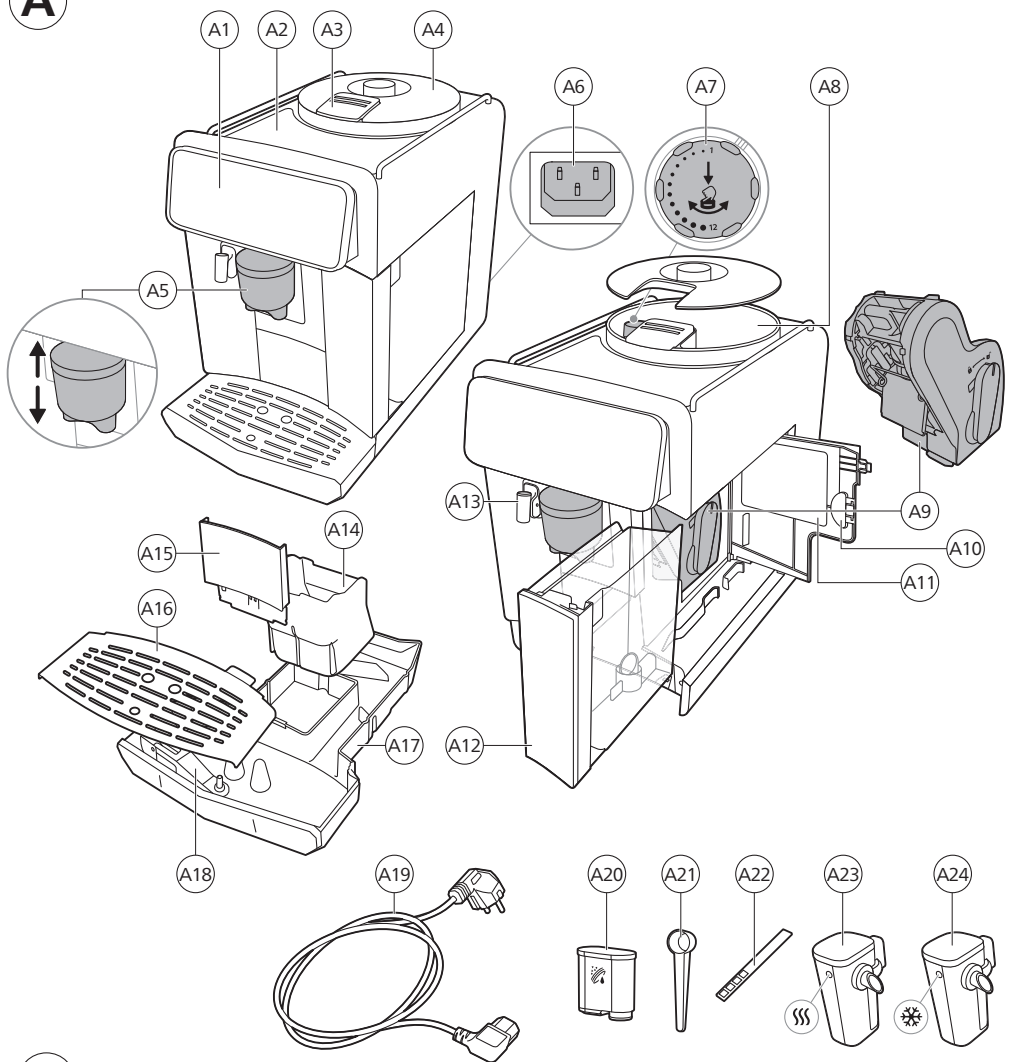

B

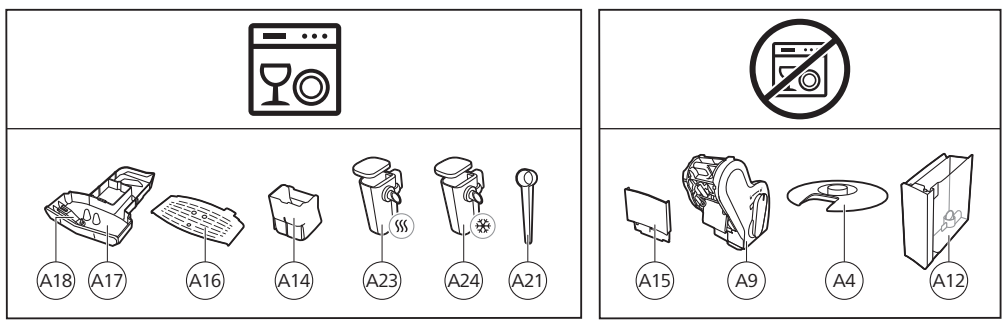

C

C1

C2

C3

C4

C5

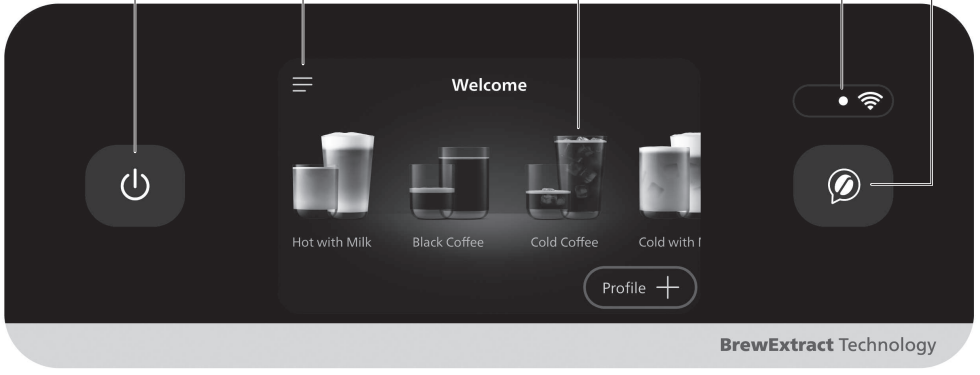

BrewExtract Technology

4 English

Contents

Machine overview (Fig. A)	4
Control panel (Fig. C)	4
Introduction	5
Before first use	5
AquaClean water filter	7
Brewing drinks	7
Personalizing drinks	10
Creating a profile	10
Adjusting machine settings	10
Removing and inserting the brew group	11
Cleaning and maintenance	12
Descaling procedure	13
Ordering accessories	14
Troubleshooting	14
Technical specifications	21

Machine overview (Fig. A)

A1 Control panel	A10 Service door
A2 Cup holder	A11 Data label with type number
A3 Pre-ground coffee compartment	A12 Water tank
A4 Lid of bean hopper	A13 Hot water spout
A5 Adjustable coffee spout	A14 Coffee grounds container
A6 Socket for power cord	A15 Front panel of coffee grounds container
A7 Grind setting knob	A16 Drip tray cover
A8 Coffee bean hopper	A17 Drip tray
A9 Brew group	A18 'Drip tray full' indicator

Accessories

A19 Power cord	A22 Water hardness test strip
A20 AquaClean water filter	A23 LatteGo Pro hot milk system
A21 Measuring scoop	A24 LatteGo Pro cold milk system

Control panel (Fig. C)

Refer to figure C for an overview of all buttons and icons. Below you find the description.

C1 On-off

C2 Menu

C3 Drink categories

C4 Wi-Fi icon

C5 Barista assistant

Introduction

Congratulations on your purchase of a Philips fully automatic coffee machine! To fully benefit from the support that we offer, please register your product at www.home.id.

Read the separate safety booklet carefully before you use the machine for the first time and save it for future reference.

Before first use, rinse with hot water all removable accessories destined to come into contact with water or milk. Switch on the machine and follow the instructions displayed to set up the machine. To help you get started and to get the best out of your machine, Philips offers support in multiple ways.

- 1 The Quick Start Guide with picture-based usage instructions and information on cleaning and maintenance.
- 2 The separate safety booklet with instructions on how to use the machine in a safe way.
- 3 For online support (this extended user manual, frequently asked questions, videos, etc.), scan the QR code on the cover of this booklet to download the HomeID App, or visit www.home.id/support.

i This machine has been tested with coffee. Although it has been carefully cleaned, there may be some coffee residues left. We guarantee, however, that the machine is absolutely new.

The machine automatically adjusts the amount of ground coffee that is used to make the best-tasting coffee. You should brew 5 coffees initially to allow the machine to complete its self-adjustment.

i When the machine has finished brewing, it switches off automatically to save energy after default time of 15 minutes.

Before first use

Setting up the machine

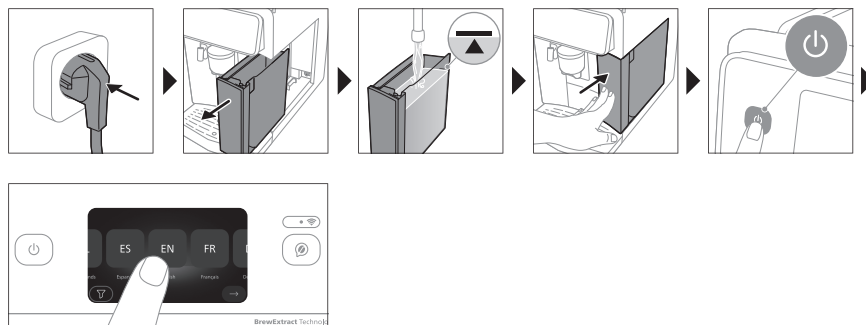

6 English

Assembling LatteGo Pro

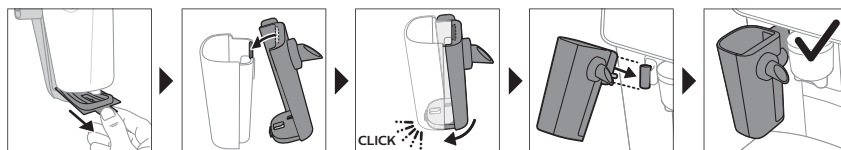

Setting the water hardness

i For best coffee experience, use fresh water. For the best coffee taste and the machine longevity, do not fill water tank with demineralized, distilled or mineral water.

i We advise you to adjust the water hardness setting to the water hardness level in your region for optimal performance and a longer lifetime of the machine. This also prevents you from having to descale the machine too often. The default water hardness setting is 4 red squares: hard water.

Use the water hardness test strip supplied in the box to determine the water hardness in your region:

- 1 Immerse the water hardness test strip in tap water or hold it under the tap for 1 second (Fig. 1).
- 2 Wait 1 minute (Fig. 2).
- 3 Scroll to select the water hardness level. The number of red squares on the screen should match the number of red squares on the test strip.
- 4 Confirm.

i You can re-set water hardness later under the Menu by tapping "Machine Settings" and scrolling to select "Water Hardness".

Connecting the machine to the HomeID App

i Make sure that you connect your machine to a 2.4 GHz home Wi-Fi network.

- 1 Download the Philips HomeID App.
 - Scan the QR code on the cover or on your Quick Start Guide, or search for Philips HomeID in the Google Play Store (Android) or App Store (iOS).
- 2 Add your machine.
 - Open the HomeID App on your smartphone and follow the instructions until you see "Add Appliance (+)".
 - Select your coffee machine.
- 3 Pair via Wi-Fi.
 - Make sure your smartphone's Wi-Fi is enabled.
 - Follow the steps on your App to complete setup.

Once connected, you become the owner of the machine. You can share access with others by inviting them via the App.

We recommend downloading the HomeID App and adding your machine to the App as soon as you set up your machine for the first time. This enables you to get the best coffee experience, such as:

- Barista assistant feature to get personal recommendations and help on adjusting coffee to your taste, choosing the right beans, exploring new drinks and much more
- Customize and brew drinks remotely
- Set a timer for your machine to wake up

- Access over 75 coffee-based recipes
- Use Alexa if available in your country to turn your machine on and brew
- Personalize your profile even more
- Get access to customer support
- Receive latest firmware updates

AquaClean water filter

Your machine is AquaClean enabled. You can place the AquaClean water filter in the water tank to preserve the taste of your coffee. It also diminishes the need for descaling by reducing limescale build-up in your machine. You can purchase an AquaClean water filter from your local retailer*, from authorized service centers or online at <https://www.home-appliances.philips/parts-accessories>.

i *Availability varies per country.

Activating the AquaClean water filter (5 min.)

i The machine does not automatically detect that a filter has been placed in the water tank. Therefore you need to activate each new AquaClean water filter that you install in the "Maintenance" menu.

When the machine stops showing the filter activation message, you can still activate an AquaClean water filter, but you will need to descale the machine first.

i Your machine has to be completely limescale-free before you start using the AquaClean water filter.

Before activating the AquaClean water filter, you have to prepare it as described on the screen.

- 1 Under the Menu, tap "Maintenance" and "Remove limescale".
- 2 Tap "AquaClean", tap "Install" and follow the steps on the screen.

i Soak the filter in water. Otherwise, air might be drawn into the machine instead of water, which makes a lot of noise and prevents the machine from being able to brew coffee.

Replacing the AquaClean water filter (5 min.)

After 95 liters of water have flowed through the filter, the filter will cease to work. The machine will remind you to replace the filter. If you do not replace the filter in time, you need to descale the machine.

- 1 Take out the old AquaClean water filter.
- 2 Install a new filter and activate it as described in chapter 'Activating the AquaClean water filter (5 min.)'.

i We advise you to replace the AquaClean water filter at least every 3 months, even if the machine does not yet indicate that replacement is required.

Brewing drinks



General steps

- 1 Switch on the machine and follow the guidelines from the screen (Fig. 3).
- 2 Fill the water tank with fresh cold water (Fig. 4) and fill the bean hopper with fresh beans (Fig. 5).
- 3 Place a cup under the adjustable coffee spout (Fig. 6).

8 English



A Use the water in the water tank within 1 to 2 days. If the machine is not used for 3 days or longer, empty the water tank, rinse it thoroughly and refill with fresh potable water before making any drink.

Brewing coffee with beans

- 1 To brew a coffee, tap a category and select a drink.
 - You can now adjust the drink to your personal taste using the Customize  icon.
- 2 Tap the Play  icon at any time to start brewing the selected drink.
- 3 To stop dispensing drink before the machine has finished, tap the Stop  icon.

A Do not use caramelized or flavored coffee beans to avoid damage of your coffee machine.

Brewing milk-based drinks with LatteGo Pro





A LatteGo Pro hot  and cold  milk systems consist of a milk container, a frame and a storage lid. To avoid leakage, make sure the frame and the milk container are properly assembled before you fill the milk container.

- 1 To assemble LatteGo Pro, first insert the top of the milk container under the hook at the top of the frame (Fig. 7). Then press home the bottom part of the milk container. You hear a click when it locks into place (Fig. 8).

i Make sure that the milk container and the frame are clean before you connect them.

- 2 Slightly tilt LatteGo Pro and put it on the hot water spout (Fig. 9). Then press it home until it locks into place (Fig. 10).
- 3 Fill the milk container with milk. Do not fill it beyond the maximum indication (Fig. 11).

v Always use milk coming directly from the fridge for optimal results.

- 4 Place a cup on the drip tray under the LatteGo Pro and adjustable coffee spout.
- 5 Tap a category and select a drink.
 - You can now adjust the drink using the Customize  icon.
- 6 Tap the Play  icon.
 - To stop dispensing milk before the machine has dispensed the preset amount, tap the Skip  icon.
 - To stop dispensing the complete drink before the machine has finished, tap the Stop  icon.

v LatteGo Pro cold system is the best choice for cold drinks, together with fully-skimmed milk.

Brewing cold drinks

Cold drinks are brewed slowly (some minutes) without heat. You will enjoy a smooth, sweet and less acidic coffee.

i We recommend to fill water tank with fresh cold water before making any cold drinks.

Brewing iced drinks

Iced drinks are brewed at a lower temperature and slower speed, resulting in a slightly sweeter and tangy flavor.

v Add ice cubes for a more refreshing result.





v Match with cold milk froth for the best taste experience.

Special functions

ExtraShot

i When you have selected the ExtraShot function, you can only brew one coffee at the time.

Your machine offers you the possibility to add an extra shot of Ristretto to your coffee and milk drinks, for example if you want to have a stronger coffee.





- 1 Place a cup under the the adjustable coffee spout.
- 2 Select a drink by scrolling and tapping on the screen.
- 3 Tap the Customize  icon on the screen.
- 4 Tap the ExtraShot  icon and tap the Play  icon to start brewing the drink.
- 5 To stop dispensing the drink before the machine has finished, tap the Stop  icon.

Pre-Ground coffee

i When you have selected the Pre-Ground function, you can only brew one coffee at the time.

i Never load more than one level measuring scoop of pre-ground coffee. We advise you to use the provided measuring scoop and use fine ground coffee which is used for espresso.

You can choose to use pre-ground coffee instead of beans, for example if you prefer a different coffee variety or decaffeinated coffee.

- 1 Open the lid of the pre-ground coffee compartment and pour one leveled measuring scoop of pre-ground coffee into it (Fig. 12). Then close the lid.
- 2 Select a drink by scrolling and tapping on the screen.
- 3 Tap the Customize  icon on the screen.
- 4 Tap the pre-ground coffee  icon and tap the Play  icon to start brewing the drink.
- 5 To stop dispensing coffee before the machine has finished, tap the Stop  icon.

Barista assistant

To fully benefit from this feature and get the best experience, ensure your coffee machine is connected to the HomeID App.

Barista assistant is your personal coffee guide, helping you get the most out of every cup through tailored settings, expert tips and bean recommendations, including:

- Adjusting settings to your beans
 - Drink rate and review
 - Bean suggestions
 - Grinding settings information
 - Tips and Tricks
 - Special recipes
- 1 Open the HomeID App on your phone.
 - 2 Tap the pop-up barista  icon to start interacting with the barista assistant to personalize your coffee experience.

Barista assistant helps you get the best taste from your coffee beans by automatically fine-tuning machine settings based on the bean type and roast level you use.



- 1 Press the barista assistant  button on the machine.
- 2 Tap "Start now" and follow the guided questions from the barista assistant.
- 3 Select the type of beans. You can choose between 100% Arabica and mix of Arabica/Robusta.
- 4 Select the roasting level of your beans among light, medium and dark.
- 5 Tap "Adjust now". The brewing settings are optimized automatically.
 - Enjoy your next coffee.

10 English

i You can simply press the barista assistant  button again when you change your coffee beans.

Dispensing hot water

i Hot water cannot be dispensed from the App.

- 1 If attached, remove LatteGo Pro.
- 2 Place a cup under the hot water spout.
- 3 Tap "Hot water".
- 4 Adjust quantity and temperature using the Customize  icon.
- 5 Tap the Play  icon. Hot water is dispensed from the hot water spout (Fig. 13).
- 6 To stop dispensing hot water before the machine has finished, tap the Stop  icon.



Personalizing drinks

The machine allows you to adjust the settings of a drink to your own preference.

- 1 Select a drink by scrolling and tapping on the screen.
- 2 Tap the Customize  icon on the screen.
- 3 Adjust settings according to the selected drink: volume, strength and temperature where available.

i Adjustable settings depend on the selected drink.

Creating a profile

- 1 On the home screen, tap "Profile +".
- 2 Scroll through the available profiles and select color.
- 3 Tap  icon to continue.
- 4 Scroll and select up to 8 favorite drinks.
- 5 Tap a preferred drink.
- 6 Tap  icon to continue.
 - Now your profile is made, you may edit it again every time you want.

i In case you do not select any profile, you can still personalize the settings to your own preference but the recipes you brew will not be stored.

Adjusting machine settings

Adjusting grinder setting

By adjusting the grinder, you may personalize your coffee to perfectly match your taste preferences.

- Level 1-6 (Fig. 14)
 - Finer grinder setting
 - The best setting if you like stronger and more bitter taste
 - Ideal for short drinks or traditional milk-based recipes such as Espresso, Ristretto and Cappuccino
- Level 7-12 (Fig. 15)
 - Coarser grinder setting
 - The best setting if you like weaker and sourer taste

- Ideal for long drinks such as Coffee, Iced Coffee and Cold Brew

For more information, please visit www.home.id.

The machine has been set up to get the best taste out of your coffee beans. Therefore we advise you not to adjust the grind setting until you have brewed 100-150 cups (approx. 1 month of use).

i You can only adjust the grinder settings when the machine is grinding coffee beans. You need to brew 2 to 3 drinks before you can taste the full difference.

A Do not turn the grinder setting knob more than one notch at a time to prevent damage to the grinder.

- 1 Place a cup under the adjustable coffee spout.
- 2 Open the lid of bean hopper.
- 3 Select a drink from the control panel and tap the Play  icon.
- 4 When the grinder starts grinding, press down the grinder setting knob and turn it to the left or right (Fig. 16).

Adjusting other machine settings

By tapping the Machine Settings icon, you can adjust the following machine settings:

- Water hardness: select between 5 levels according to the water hardness in your region
- Standby time: select 15, 30, 60 or 180 min
- Display brightness: select low, medium or high
- Display back light: select 'always on' or 'dim after 3 mins'
- Cup light: select 'always off', 'always on', 'always dimmed' or 'on while brewing'
- Language
- Sound: activate or deactivate the beeping sound of the machine
- Measuring units: select ml. or oz.
- Rinsing: activate or deactivate an automatic rinsing cycle when you switch on the machine
- Home screen: select 'show drinks overview' or 'show last used profile'
- Eco mode: activate or deactivate automatic adjustment of your settings to the most energy efficient option
- Factory settings: reset your machine to default settings

Restoring factory settings

The machine offers you the possibility to restore the factory settings at any moment.

- 1 Under the Menu, tap "Machine Settings" and "Factory Settings".
- 2 Tap "Reset" and confirm.
 - The settings are now being restored.

i All the following machine settings will be restored except statistics: water hardness, standby time, display brightness, display back light, cup light, language, sound, measuring units, rinsing, home screen, eco mode.

i In addition, stored Wi-Fi credentials and pairing with HomeID account will be lost.

Removing and inserting the brew group

Go to www.home.id/support for detailed video instructions on how to remove, insert and clean the brew group.

Removing the brew group from the machine

- 1 Remove the water tank and open the service door (Fig. 17).

12 English

- 2 Unlock the brew group by moving the yellow handle to the right (Fig. 18).
- 3 Slide the brew group from the machine (Fig. 19).

Reinserting the brew group

- 1 Slide the brew group back in until it clicks in the position (Fig. 20).
- 2 Lock the brew group by moving the yellow handle to the left (Fig. 21).
- 3 Close the service door and place the water tank back into the machine.

Cleaning and maintenance

Regular cleaning and maintenance keeps your machine in top condition and ensures good-tasting coffee for a long time with a steady coffee flow.

Consult the table below for a detailed description on when and how to clean all detachable parts of the machine. You can find more detailed information and video instructions on www.home.id/support. See figure B for an overview of which parts can be cleaned in the dishwasher.

Detachable parts	When to clean	How to clean
Brew group	Weekly	Remove the brew group from the machine. Rinse it under the tap (see 'Cleaning the brew group under the tap').
Brew group	Monthly	Clean the brew group with the Philips coffee oil remover tablet (see 'Cleaning the brew group with the coffee oil remover tablets').
Pre-ground coffee compartment	Check the pre-ground coffee compartment weekly to see if it is clogged.	Unplug the machine and remove the brew group. Open the lid of the pre-ground coffee compartment and insert the spoon handle into it. Move the handle up and down until the clogged ground coffee falls down (Fig. 22). Go to www.home.id/support for detailed video instructions.
Coffee grounds container	Empty the coffee grounds container when prompted by the machine. Clean it weekly.	Remove the coffee grounds container while the machine is switched on. Rinse it under the tap with some washing-up liquid or clean it in the dishwasher. The front panel of the coffee grounds container (Fig. A15) is not dishwasher-safe.
Drip tray	Empty the drip tray daily or as soon as the red 'drip tray full' indicator pops up through the drip tray (Fig. 23). Clean the drip tray weekly.	Remove the drip tray (Fig. 24) and rinse it under the tap with some washing-up liquid or clean it in the dishwasher. The front panel of the coffee grounds container (Fig. A15) is not dishwasher-safe.
LatteGo Pro	After every use	Clean LatteGo Pro attached to the machine by using the 'Clean LatteGo Pro' program (see 'Cleaning LatteGo Pro'). Remove it from the machine (Fig. 25) and rinse it under the tap or clean it in the dishwasher.

Detachable parts	When to clean	How to clean
Water tank	Before every refill	Rinse the water tank under the tap before refilling with fresh water.
Machine front	Weekly	Clean with a non-abrasive cloth.

Cleaning the brew group

Regular cleaning of the brew group prevents coffee residues from clogging up the internal circuits. Visit www.home.id/support for support videos on how to remove, insert and clean the brew group.

Cleaning the brew group under the tap

- 1 Remove the brew group.
- 2 Rinse the brew group thoroughly with water and remove any coffee residues left on the brew group flap (Fig. 26).
- 3 Place the brew group back into the machine (Fig. 20).

i Do not dry the brew group with a dry cloth to prevent fibers from collecting inside.

Cleaning the brew group with the coffee oil remover tablets

To clean the brew group, we recommend to use Philips coffee oil remover tablets if available in your country.

- 1 Under the Menu, tap "Maintenance" and "Remove Coffee Oil".
- 2 Follow the steps on the screen.
 - Tap the Play  icon.

Cleaning LatteGo Pro

Quickly cleaning LatteGo Pro

- 1 Make sure LatteGo Pro is properly attached to the machine.
- 2 Place a cup under the hot water spout.
- 3 Under the Menu, tap "Maintenance" and "Clean LatteGo Pro".
- 4 Tap "Start" and follow the steps on the screen.
 - Small jets of hot water will be dispensed by the LatteGo Pro.
- 5 Store LatteGo Pro with the remaining milk in the fridge.

Thoroughly cleaning LatteGo Pro

- 1 Remove LatteGo Pro from the machine.
- 2 Pour out any remaining milk.
- 3 Press the release button and remove the milk container of the LatteGo Pro you want to clean (Fig. 27).
- 4 Clean all parts in the dishwasher or under the tap with lukewarm water and some washing-up liquid.

Descaling procedure

To clean and descale the machine, we recommend to use the Philips maintenance products if available in your country. Under no circumstances should you use a descaler based on sulfuric acid, hydrochloric acid, sulfamic or acetic acid (vinegar) as this may damage the water circuit in your machine and not dissolve the limescale properly. Failure to descale the appliance will also void your warranty. You can buy Philips descaling solution in the online shop at <https://www.home-appliances.philips/parts-accessories>.

14 English

When the machine needs descaling, the machine will advise you to descale.

- 1 Under the Menu, tap "Maintenance" and "Remove Limescale".
- 2 Tap "Descale" and follow the steps on the screen.

 Tip: Using the AquaClean filter reduces the need for descaling!

What to do if the descaling procedure is interrupted

 You can exit the descaling procedure by long pressing the On-off button on the control panel.

If the descaling procedure is interrupted before it is complete, do the following:

- 1 Empty and rinse the water tank thoroughly.
- 2 Fill the water tank with fresh water up to the Calc / Clean level indication and switch the machine on.
- 3 Before brewing any drinks, perform a manual rinsing cycle.
 - Dispense half a water tank of hot water by repeatedly selecting the hot water function.
 - Brew several cups of pre-ground coffee without adding ground coffee.

 If the descaling procedure is not complete, the machine will require another descaling procedure as soon as possible.

Ordering accessories

To clean and descale the machine, we advise you to use the Philips maintenance products such as descaling solution, AquaClean water filter and coffee oil remover tablets if available in your country. These products can be purchased from your local retailer, from the authorized service centers or online at

<https://www.home-appliances.philips/parts-accessories>. To find a full list of spare parts online, enter the model number of your machine. You can find the model number on the inside of the service door (Fig. A11).

 Brita-filters are not compatible with this machine.

Troubleshooting

This chapter summarizes the most common problems you could encounter with the machine. If you are unable to solve the problem, contact the Consumer Care Center in your country or go to www.home.id/support for support videos and a complete list of frequently asked questions.

Warning icons

Warning

Solution

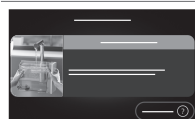

The 'Add water' screen pops up.

- The water tank is almost empty. Fill the water tank with fresh water to the maximum level indication.
- The water tank is not in place. Place back the water tank.

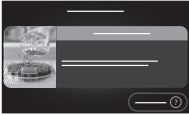
Warning**Solution**

- The 'Add beans' screen pops up.
- Fill the bean hopper with coffee beans.



- The 'Empty coffee grounds container' screen pops up.
- The coffee grounds container is full. Remove and empty the coffee grounds container while the machine is switched on. Wait 5 seconds before you place it back.



- The 'Insert brew group' screen pops up.
- The brew group is not in place or not placed correctly. Remove the brew group and make sure it is locked into place. See chapter 'Removing and inserting the brew group' for step-by-step instructions.

Error codes

Below you find a list of the error codes showing problems that you can solve yourself. Video instructions are available on www.home.id/support. If another error code appears, please contact the Philips Consumer Care Center in your country. For contact details, see the warranty leaflet.

Error code	Problem	Possible solution
01	The coffee funnel is clogged.	Switch off the machine and unplug it. Remove the brew group. Then open the lid of the pre-ground coffee compartment and insert the spoon handle (Fig. 22). Move the handle up and down until the clogged ground coffee falls down. Visit www.home.id/support for detailed video instructions.
03	The brew group is dirty.	Rinse the brew group with tap water and let it air-dry or dry with a soft, damp cloth. Consult chapter 'Cleaning the brew group' or visit www.home.id/support for detailed video instructions.
04	The brew group is not positioned correctly.	Remove the brew group and reinsert it. Make sure that the brew group is in the correct position before you insert it. Consult chapter 'Reinserting the brew group' or visit www.home.id/support for detailed video instructions.
05	There is air in the water circuit.	Restart the machine by switching it off and on again. If this works, dispense 2-3 cups of hot water. Descale the machine if you have not done so for a longer period of time.
05	The AquaClean water filter is not installed properly or is clogged.	Remove the filter and try to brew a coffee again. If this works, place the filter back into the water tank properly. If this still does not work, the filter might be clogged and needs to be replaced.
11	Machine needs to adjust to room temperature	Allow some time for the machine to adjust from transport/outdoor temperature to room temperature. Switch off the machine for 30 minutes and switch it on again. If this does not work, contact the Consumer Care Center in your country.

Error code	Problem	Possible solution
14	The machine is overheated.	Switch the machine off and switch it on again after 30 minutes.
19	The machine is not connected to the wall socket properly.	Make sure that the small plug of the power cord is properly connected to the socket on the back of the machine. If this does not work, contact the Consumer Care Center in your country.

Troubleshooting table

This chapter summarizes the most common problems you could encounter with the machine. Support videos and a complete list of frequently asked questions are available on www.home.id/support. If you are unable to solve the problem, contact the Consumer Care Center in your country. For contact details, see the warranty leaflet.

Problem	Cause	Solution
There are some coffee residues inside your new coffee machine.	This machine has been tested with coffee.	Although it has been carefully cleaned, there may be some coffee residues left. However, the machine is absolutely new.
The drip tray fills up quickly or there is always some water in the drip tray.	This is normal. The machine uses water to rinse the internal circuit and brew group. Some water flows through the internal system directly into the drip tray.	Empty the drip tray daily or as soon as the red 'drip tray full' indicator pops up through the drip tray cover. Tip: place a cup under the dispensing spout to collect rinsing water that comes out of it.
The 'Empty coffee grounds container' screen remains on.	You emptied the coffee grounds container while you switched off the machine or you placed it back too fast.	Empty the coffee grounds container while the machine is switched on. Remove the coffee grounds container, wait at least 5 seconds and then place it back.
The machine prompts to empty the coffee grounds container even though the container is not full.	The machine does not reset the counter the last time you empty the coffee grounds container.	Wait about 5 seconds when you place back the coffee grounds container. In this way the coffee grounds counter will be reset to zero and the number of coffee pucks is counted correctly.
		Empty the coffee grounds container while the machine is switched on. If you empty the coffee grounds container when the machine is switched off, the coffee grounds counter won't reset.
The coffee grounds container is too full and the 'Empty coffee grounds container' screen does not appear.	You removed the drip tray without emptying the coffee grounds container.	When you remove the drip tray, empty the coffee grounds container even if it contains only a few coffee pucks. This ensures that the coffee pucks counter is reset to zero and that the number of coffee pucks is counted correctly.

Problem	Cause	Solution
You cannot remove the brew group.	The brew group is not in the correct position.	Reset the machine in the following way: close the service door and place back the water tank. Switch the machine off and back on. Try again to remove the brew group. See chapter 'Removing and inserting the brew group' for step by step instructions.
You cannot insert the brew group.	The brew group is not in the correct position.	Leave the brew group out and reset the machine in the following way: close the service door and place back the water tank. Switch the machine off and unplug it. Wait for 30 seconds, plug the machine back in and switch it on. Then try again to reinsert the brew group into the machine. See chapter 'Removing and inserting the brew group' for step by step instructions.
The coffee is watery.	The brew group is dirty.	Remove the brew group, rinse it under the tap and leave it to dry.
	The machine is performing its self-adjustment procedure. This procedure starts automatically when you use the machine for the first time, when you change to another type of coffee beans or after a long period of non-use.	Brew 5 cups of coffee initially to allow the machine to complete its self-adjustment procedure.
	The grinder setting is too coarse.	Adjust the grinder to a finer (lower) setting (Fig. 16). Brew 2 to 3 drinks to be able to taste the full difference (see 'Adjusting grinder setting').
The coffee is not hot enough.	The temperature is set too low.	Adjust the temperature for the desired drink using Customize  icon.
	The automatic rinsing cycle is disabled.	Activate the automatic rinsing cycle in the Settings. The machine will heat up and perform an automatic rinsing cycle when you turn on the machine.
	A cold cup reduces the temperature of the coffee.	Preheat the cups by rinsing them with hot water.
	Adding milk reduces the temperature of the coffee.	Regardless of whether you add hot or cold milk, adding milk always reduces the temperature of the coffee. Preheat the cups by rinsing them with hot water.
Coffee does not come out or coffee comes out slowly.	The AquaClean water filter is not prepared properly for installation.	Remove the filter and dispense some hot water. If this works, the filter was not installed properly. Reinstall and activate the filter and follow all steps in chapter 'AquaClean water filter'.

Problem	Cause	Solution
		After a long period of non-use, prepare the filter for use again and dispense 2-3 cups of hot water.
	The AquaClean water filter is clogged.	Replace the filter every 3 months or when advised by your machine.
	The grinder setting is too fine.	Adjust the grinder to a coarser (higher) setting (Fig. 16). Note that this will impact the coffee taste (see 'Adjusting grinder setting'). Brew 2 to 3 drinks to be able to taste the full difference.
	The brew group is dirty.	Remove the brew group and rinse it under the tap (see 'Cleaning the brew group under the tap').
	The adjustable dispensing spout is dirty.	Clean the adjustable dispensing spout and its holes with a pipe cleaner or needle.
	The pre-ground coffee compartment is clogged.	Remove the brew group. Open the lid of the pre-ground coffee compartment and insert the spoon handle into it (Fig. 22). Move the handle up and down until the clogged ground coffee falls down. Place the brew group back and lock in place. Restart your machine.
	The machine circuit is blocked by limescale.	Descale the machine with Philips descaler when the machine prompts you.
The milk does not froth.	LatteGo Pro is assembled incorrectly.	Make sure that the milk container is properly assembled to the frame of LatteGo Pro (you hear 'click' sound).
	The milk container and/or frame of LatteGo Pro are/is dirty.	Disassemble LatteGo Pro and rinse both parts under the tap or clean them in the dishwasher.
	The type of milk used is not suitable for frothing.	Different types of milk result in different amounts of froth and different froth qualities. Use Barista types of milk for best results. <ul style="list-style-type: none"> - For best result with cold froth, we recommend to use skimmed milk. - For best result with hot froth, we recommend to use semi-skimmed milk.
Milk is leaking from the bottom of the LatteGo Pro.	The frame and the milk container are not assembled properly.	Insert the top of the milk container under the hook at the top of the frame and press home the bottom part of the milk container. You hear a click when it locks into place.

Problem	Cause	Solution
	The milk container and/or frame of LatteGo Pro are/is dirty.	Disassemble LatteGo Pro and rinse both parts under the tap or clean them in the dishwasher.
The machine seems to be leaking.	The machine uses water to rinse the internal circuit and brew group. This water flows through the internal system directly into the drip tray, which is normal.	Empty the drip tray every day or as soon as the 'drip tray full' indicator pops up through the drip tray cover. Tip: Place a cup under the adjustable coffee spout and hot water spout to collect water.
	The drip tray is too full and has overflowed.	Empty the drip tray every day or as soon as the 'drip tray full' indicator pops up through the drip tray cover (Fig. 24).
	The water tank is not fully inserted. Some water is leaking out of the water tank and air is drawn into the machine.	Remove the water tank and place it back in the correct position.
	The brew group is dirty or clogged.	Rinse the brew group under the tap.
	The machine is not placed on a horizontal surface.	Place the machine on a horizontal surface so that the drip tray does not overflow and the 'drip tray full' indicator works properly.
You cannot activate the AquaClean water filter and the machine asks for descaling.	You did not replace the filter in time after the screen shows the AquaClean reminder. This means your machine is not anymore completely limescale free.	Descale your machine and install the filter.
The new water filter does not fit.	You install another filter than the Philips AquaClean water filter.	Only use the Philips AquaClean water filter.
	The rubber ring on the AquaClean water filter is not in place.	Place back the rubber ring on the filter.
The machine is making a loud noise.	It is normal that your machine makes some noise during use.	If the machine starts to make a different kind of noise, clean the brew group.
	The AquaClean water filter is not prepared properly and air is drawn into the machine.	Remove the filter from the water tank and properly prepare it for use before you place it back. See chapter 'AquaClean water filter' for step-by-step instructions.
	The water tank is not fully inserted and air is drawn into the machine.	Remove the water tank and place it back in the correct position.
The machine cannot connect to Wi-Fi during initial setup.	The machine and Wi-Fi router are not within range of each other.	Ensure that the machine and the Wi-Fi router are within range of each other or use a Wi-Fi repeater.

Problem	Cause	Solution
	The Wi-Fi router is not working properly.	Ensure that the Wi-Fi router is working properly and is connected to the internet.
	The router your machine is trying to connect to is 5 GHz band.	5 GHz networks are not supported. Hence make your router supporting dual bands: both 5 GHz and 2.4 GHz.
The machine is experiencing connection issues.	The Wi-Fi router is not working properly.	Ensure that your Wi-Fi router is functioning correctly and is connected to the internet.
	The Wi-Fi connectivity is interrupted by electromagnetic or other interferences.	Reduce interference by moving other devices away or switching them off.
	Connection with Cloud	Check the Wi-Fi indicator on your machine. If it is off or blinking fast, go to Machine Settings > Connected Settings > Wi-Fi, and tap "Forget Network" to reset. Then, reconnect your machine using the HomeID App.
The machine cannot connect to Wi-Fi after changing internet provider or router.	New router settings are not compatible with the machine.	Check if it supports 2.4 GHz Wi-Fi network.
	The machine is still paired with your previous Wi-Fi network and cannot recognize the new router.	Reset the Wi-Fi: Go to Machine Settings > Connected Settings > Wi-Fi, and tap "Forget Network". Reconnect your machine using the HomeID App.
Other users are not able to control the machine via the App.	You haven't received or accepted a sharing invitation from the machine owner.	Ensure you have received and accepted a sharing invitation from the machine owner.
Other users can no longer control the machine via the App.	The machine owner has removed the machine from their HomeID App account.	Open the HomeID App and follow the pairing process under 'Add Appliance'. Once paired, the user becomes the new machine owner and can invite others again.
The App is not working.	Temporary phone or HomeID App issue.	Close and restart the HomeID App or your phone. Ensure you install the latest version of the HomeID App (check for updates in your App Store or Google Play). Empty the cache of your phone (Settings > HomeID > Empty Cache). If needed, uninstall and reinstall the HomeID App.

Checking your Wi-Fi indicator status

Status	Meaning
---------------	----------------

Off	Machine is not connected to Wi-Fi.
Blinking slowly	Machine is pairing to the router.
On	Machine is connected to Wi-Fi.
Blinking fast	Wi-Fi connection error.

Technical specifications

The manufacturer reserves the right to improve the technical specifications of the product. All the preset quantities are approximate.

Description	Value
Size (w x h x d)	251 x 389 x 452 mm
Weight	8.5 - 9 kg
Power cord length	800 - 1200 mm
Water tank	1.9 litres
Coffee bean hopper capacity	275 g
Coffee grounds container capacity	up to 12 pucks
LatteGo Pro capacity	250 ml
Adjustable coffee spout height	88 - 145 mm
Nominal voltage - Power rating - Power supply	See data label inside the service door (Fig. A11)

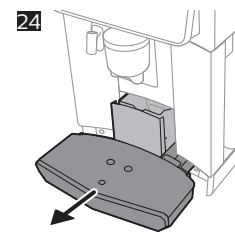
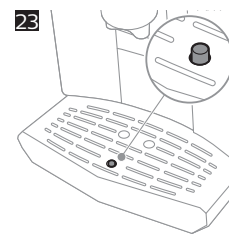
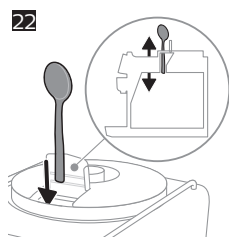
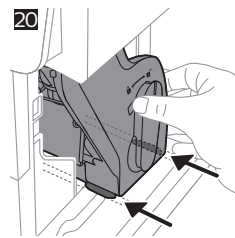
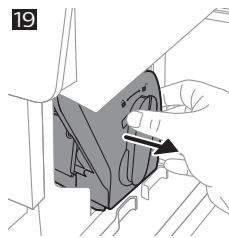
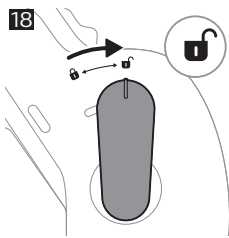
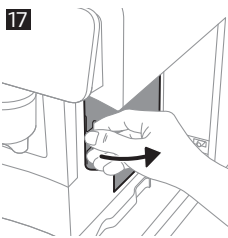
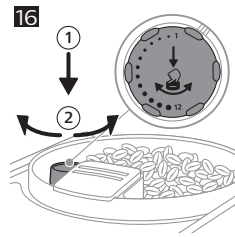
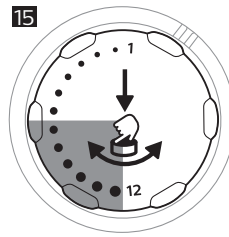
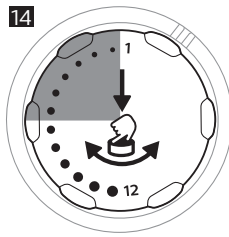
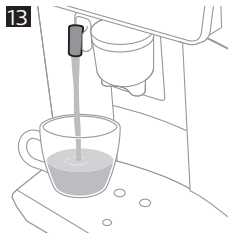
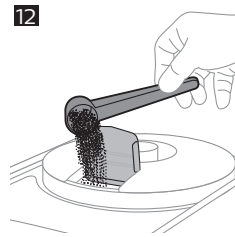
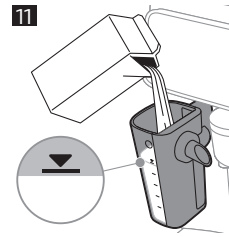
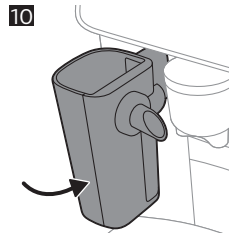
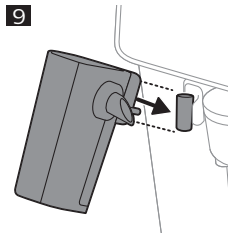
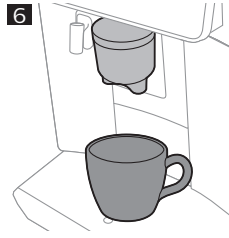
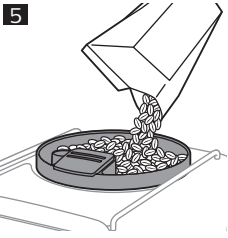
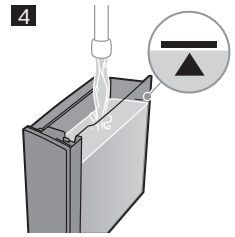
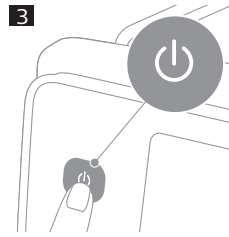
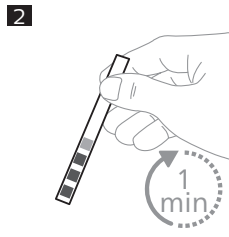
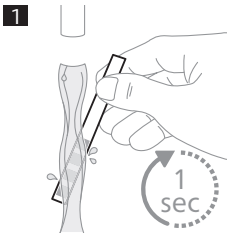

25



26

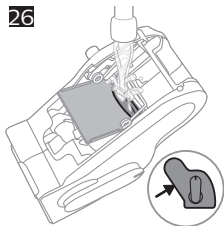

27

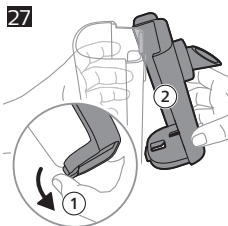

2024 © Versuni Holding B.V.

PHILIPS and the Philips Shield Emblem are registered trademarks of Koninklijke Philips N.V. and are used under license.

This product has been manufactured by and is sold under the responsibility of Versuni Holding B.V., and Versuni Holding B.V. is the warrantor in relation to this product.

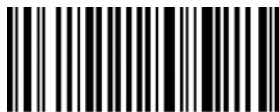

642001018582

www.home.id



100% recycled paper
100% papier recyclé